

PLANNING BASICS

CONVEYING GOOD

Conveying good

This chapter is intended to provide support in the planning of conveyor systems and the selection of matching products.

The properties of the conveying good, the requirements with regards the conveyor system and the ambient conditions are the basis for the planning of the system.

Length and width of conveying good

The length and width of the conveying good have an effect on several factors:

Straight running: The higher the ratio of length to width, the more stable will be the straight running of your items. With smaller length to width ratios, it may be necessary to put in place additional measures to stabilize the straight running of the conveying goods.

Reference length: As a rule, the reference length corresponds to the conveyor width +50 mm or for large conveying goods, such as pallets, +100 mm. In curves, Interroll recommends the use of tapered conveyor rollers and RollerDrive whose length must be calculated separately (see page 194).

Roller pitch: To transport the conveying good without problems, the roller pitch must be selected so that the conveying good is carried by three conveyor rollers at any given time.

Surface pressure: The different Interroll Conveyor Rollers and RollerDrive can be loaded with different forces. The static load capacity can be taken from the respective chapter. The values are based on the assumption that a conveying good rests on the complete usable tube length and not just on a part of it. If a conveying good has contact with less than approx. 50 % of the usable tube length, please have the application checked by Interroll beforehand.

Very long conveying goods generally do not rest on all conveyor rollers and RollerDrive that are located under them. If, for example, 20 conveyor rollers are under a piece of conveying good, but the conveying good contacts only 15 conveyor rollers, then the load capacity of a roller must be greater than one-fifteenth of the conveying good weight. For very long conveying goods, the tolerance of the roller fastening height for conveyor rollers and RollerDrive should be kept as low as possible so that as many conveyor rollers as possible can carry the conveying good.

Height of conveying good

The greater the height of the conveying good in relation to its bottom area, the higher is the risk of it tipping over when traveling on the conveyor. The following must be taken into consideration:

- Minimize the roller pitch as much as possible to ensure that the products are conveyed smoothly with as large a base surface as possible.
- Avoid rapid acceleration and harsh braking. Use MultiControl as far as possible for controlling EC5000. These control systems allow for purposeful matching of acceleration and deceleration of the RollerDrive.
- With inclined conveyor tracks, determine the center of gravity of the conveying good and check whether there is a risk of it tipping.

Weight and weight distribution of the conveying good

The weight of the conveying good must be distributed on a number of conveyor rollers so that the maximum load capacity of the individual conveyor roller and RollerDrive is not exceeded. This may mean that more than three conveyor rollers must support the conveying good.

In principle the weight of the conveying good should be distributed as evenly as possible. The more uneven the weight distribution is, the more difficult a reliable conveyance is.

If the weight of the goods is mostly at the front, then it is very likely that the rollers at the end of the load carrier support only very little weight. In the worst case scenario, the rollers at the start of the load carrier could be overloaded.

The load capacity increases with larger tube diameter. For heavy conveying goods, RollerDrive with a diameter of 60 mm should be used instead. The load capacity is increased by rollers with threaded shafts. In addition, the shafts reinforce the conveyor and act as a cross tie.

Drive elements, such as round belts or toothed belts, must also be selected while taking the conveying good weight into consideration. Interroll recommends PolyVee belts for conveying containers and cardboard cartons. Their service life and torque transmission is significantly higher compared to round belts.

Material of conveying good

The material, and especially the condition of the base, has an effect on the rolling and starting resistance.

Hard materials, such as polymer containers, feature lower rolling and starting resistances than soft materials, such as cardboard cartons. This has a direct impact on the required drive output and must be included in its calculation. The softer the underside of the conveying good, the higher is the drive output required for a product with the same weight but with a hard underside. In principle, the softer the conveying good, the smaller the roller pitch needs to be.

The following graphic describes which tube material or which tube add-on offers the best friction for various conveying goods materials. The darker the color, the higher the friction.

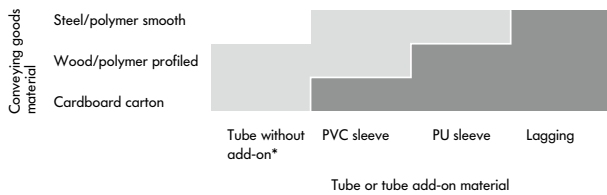

* Applies to zinc-plated and stainless steel tubes as well as PVC tubes.

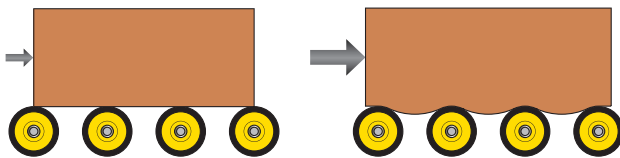

Ribs, keyways, strips or grooves in the bottom of conveying goods that run parallel to the direction of conveyance, do not pose a problem concerning transportability. The required drive output increases depending on their shape. Cross ribs can negatively impact the transporting. It may be necessary to determine the roller pitch empirically.

When checking whether a roller has sufficient load capacity for an application, it is important to take the condition of the conveying goods into consideration. Conveying goods with an uneven bottom generally do not rest on all rollers that are located under them. With pallets, it must be ensured that only the rollers under the bulk of the pallet are actually bearing the load. The following diagram shows which runner load distribution occurs for an evenly loaded euro pallet.

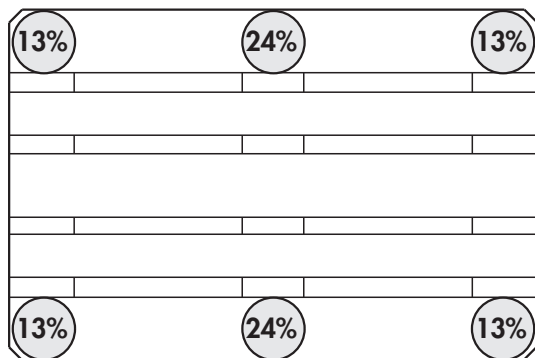

Fig.: Support of 2 runners

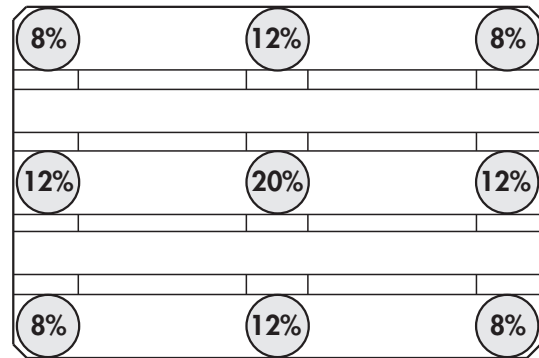

Fig.: Support of 3 runners

Conveyor requirements

The following fundamental parameters determine the configuration of the conveyor:

- Maximum throughput per time unit
- Geometry of conveying good
- Weight and weight distribution of the conveying good
- Control requirements
- Environmental conditions

The topic of environmental conditions is discussed below.

Static charging

In principle, conveyance via rollers creates electrostatic charging which, among other things, depends on the properties of the conveying good and the tube material.

To prevent electrostatic charging from occurring or dissipate it immediately and without creating sparks, Interroll offers antistatic versions for rollers with steel tube. RollerDrive feature an antistatic design in principle. Sleeves, lagging and gray tapered elements do not feature an antistatic design. For this reason, Interroll recommends the use of black tapered elements for curves.

Antistatic conveyor rollers and RollerDrive require the proper manufacturing and check of the conducting connection between shaft and side profile and the grounding of the side profile by the system manufacturer.

Noise level

Noise is created by different components of a conveyor and the conveying good itself.

Every drive creates noise. The RollerDrive is designed with decoupling elements which reduce the noise of the gear box. In most cases, the noise level of the RollerDrive is below 50 dBA.

PLANNING BASICS

CONVEYOR REQUIREMENTS

More and more zero-pressure accumulation conveyor systems are converted from pneumatic solutions with a centrally arranged drive to a RollerDrive solution. The significantly lower noise level is a deciding factor here.

The following applies to the noises of drive elements: A chain drive causes more noise than a belt drive. At high accelerations and decelerations, slipping round belts can cause squealing noises. Interroll recommends reducing the acceleration and deceleration of RollerDrive or using PolyVee belts. In this case, the risk of squealing noises is greatly minimized.

Very quiet rollers, RollerDrive and drive elements are of little use if the conveying good on the conveyor creates noise. Various measures can counteract it. The following should be observed in this case:

- A small roller pitch generally causes less noise than a large roller pitch.
- Keep height tolerances at transitions from conveyors and at the fastening of rollers/RollerDrive as small as possible.
- Fitting the rollers/RollerDrive with noise-reducing materials, e.g. with a PVC or PU sleeve
- Use of noise reduction inside of rollers for rollers with a diameter of 50 mm.

Humidity

Humidity can occur in different forms as a result of the following:

- moist conveying goods, e.g. bottle crates stored in the rain
- moist environment, e.g. sculleries
- applications that become moist, e.g. because of cleaning or tripped sprinkler systems

If humidity can be expected in a system, then all components should be checked for corresponding resistance.

Interroll offers a series of products that are suitable for applications with humidity, water exposure, or water jets:

Tube material: Rollers and RollerDrive can be manufactured from rust-free material, such as stainless steel. In addition, materials can be protected with different finishing processes, such as zinc-plating.

Shaft material: Shafts for conveyor rollers can be manufactured from rust-free material, such as stainless steel.

Drives: The RollerDrive already has a high degree of protection with protection rating of IP54. If water jets can be expected in the application, Interroll recommends the design with protection rating IP66.

Bearing: All rollers with precision ball bearings are well protected against moisture and dust. For systems with constant humidity or moisture, Interroll offers designs with stainless steel ball bearings.

Applications in deep freeze area

Applications with an ambient temperature of approx. $-30\text{ }^{\circ}\text{C}$ are particularly prevalent in the food processing sector. Many items must be taken into account in the so-called deep freeze area:

- Changed starting torque of conveyor rollers and drives.
- Increased viscosity of greases, e.g. in ball bearings or gear boxes.
- Possibly frozen and, therefore, less flexible components, such as drive elements.
- Functional safety of all components through different contraction of various materials.

The solutions from Interroll

Materials: For various products, Interroll offers variants that are particularly suited for deep freeze applications. The tapered elements for conveyor rollers and RollerDrive are manufactured impact-resistant. Conventional materials used are often brittle and break easily. The bearing housings of series 1700 are designed as high impact-resistant for deep freeze applications.

Drive elements: Before using a drive element, its suitability for deep freeze applications should be checked. It should also be ensured that the friction at temperatures below zero is sufficient and the drive elements cannot freeze since frozen drive elements could pose unplanned torque requirements for the drive. The PolyVee belts offered by Interroll are suitable for deep freeze application (see page 182).

Bearing: The precision ball bearings used also work in deep freeze conditions. However, the startup of the roller is higher in this case than at an ambient temperature of $20\text{ }^{\circ}\text{C}$. RollerDrive are either designed for this higher startup, or oiled ball bearings are being used. The oiled bearings run significantly smoother at temperatures below zero.

For functional reliability, a PolyVee drive head is not only pressed into the steel tube, but it is also flanged.

Under deep freeze conditions, materials such as steel and technopolymers contract in different ways. Very low humidity can also have an impact on the dimensional stability.

Additional security is provided by a metal star. This laser-cut star is engaged in the drive head and channels itself into the tube. This innovative interior solution eliminates interfering edges on the outer contour of the roller or RollerDrive. We recommend this form-fit connection for all deep freeze applications as well as

applications with a humidity of < 10 %. In the RollerDrive, a form-fit connection is established via the metal star, and this can be optionally used for rollers of series 3500 and 3500KXO.

Drive concepts

With respect to drives, Interroll distinguishes between drives (such as round belts, PolyVee belts, chains, etc.) and the actual drive. Different drives are used in conveyor systems, such as drum motors, gear motors, motor rollers, etc. Furthermore, the potential energy of conveying good, e.g. on gravity conveyors, is also being utilized.

Gravity conveyors

A gravity conveyor differs significantly from the other concepts. It is not horizontally aligned, but always mounted at an incline. There are driven and non-driven gravity conveyors. Driven gravity conveyors can transport conveying goods upwards and downwards. These conveyors can be driven with RollerDrive. If the RollerDrive and, as such, the conveyor is stopped, the conveying goods remain in place and do not slide downward. The EC5000 holds its position with a certain torque which prevents any downward sliding. The different gear boxes and powers offer different zero motion holds. It must be ensured that conveying goods do not slide over standing rollers; if necessary, friction must be increased, e.g. with the use of PVC or PU sleeve on rollers, RollerDrive and Stop Roller. Gravity conveyors use the potential energy of conveying goods. This means that other technology must first move the conveying good to a corresponding spatial height.

The conveying good rolls without additional drive as a result of the potential energy up to the end of the conveyor or up to the preceding conveying good. The speed and the restart capability of conveying goods is heavily influenced by:

- The incline of the conveyor
- The already existing speed of a conveying good when placed upon the gravity conveyor
- The ease of movement of the rollers
- The conveyor length
- The condition of the underside of a conveying good
- The weight of the conveying good
- Other properties

On the one hand, the conveying good must reach the end of the conveyor. It must not stop because its weight is too low to start moving rollers at rest. If many conveying goods are already on a gravity conveyor and, as a result, a piece of conveying good stops in the last section of the conveyor, then it must be ensured that the last item will start again and reach the end of the gravity conveyor after the first conveying goods have been conveyed.

On the other hand, the speed of the conveying goods must not be or get too high. There is the risk that a conveying good hits another jammed conveying good or the end stop at the end of the conveyor. This creates an injury risk for employees who may want to remove the conveying good by hand, as well as the risk of damaging the conveying good.

Establishing the matching properties of a gravity conveyor becomes a challenge if different conveying goods have to be moved. Generally, the conveying goods on a gravity conveyor differ by at least one of the following properties: Weight, size, material and base condition. A mixture of different conveying goods can also be transported by a gravity conveyor with respect to personnel and conveying good safety as well as process reliability. Interroll offers different products for this purpose. The rollers of series 1100 are designed for use in gravity conveyors.

The magnetic speed controller MSC 50 enables the restart of conveying goods starting at 0.5 kg and reliably decelerates conveying goods up to 35 kg depending on the properties of the conveyor. If conveying goods are lighter than 0.5 kg or heavier than 35 kg, it is also possible to use the RollerDrive series EC5000.

The driven RollerDrive ensures that every lightweight conveying good, regardless of its weight, can be moved or moved again. When decelerating heavy conveying goods, the energy recovered by the RollerDrive must not be too high. If one or several RollerDrive are used within a gravity conveyor, it also provides the advantage of accumulation pressure reduction. If a RollerDrive, which may be connected with additional rollers via drive elements, is stopped, then the conveying goods stop. This allows reducing the pressure on conveying goods that are already on the conveyor or on the stop at the end of the conveyor. On long gravity conveyors, it may be advisable to use several RollerDrive in order to reduce the accumulation pressure even further. If the incline is so high that conveying goods slide over the steel tube of a stopped RollerDrive, rollers or Stop Roller, then the friction may be increased with a PVC or PU sleeve on the tube.

In principle, it is recommended to test every gravity conveyor design under original conditions.

If drives are used in gravity conveyors, it must be ensured that they hold the conveying goods at standstill. But this is possible only if the drives are supplied with voltage. If the system voltage fails, all conveying goods will move downwards. This can be prevented with the Stop Roller that is designed for this application case. It is also connected to the system voltage and stops the conveying goods as soon as the voltage is lost. It is recommended to connect the Stop Roller, RollerDrive and rollers used via PolyVee belt. Due to dynamic braking torques, 3-rib or 4-rib PolyVee belts should be used.

PLANNING BASICS

DRIVE CONCEPTS

Fixed drive conveyor

If a conveying good moves in harmony with the drive, then it is generally a fixed or constantly driven conveyor. The drive head of the rollers used is permanently connected with the tube. If the fixed drive heads are replaced with friction drive heads, they create a friction conveyor. Many different types of fixed drive conveyors are possible. They generally differ with respect to the selected drive element, such as chains, PolyVee belts, round belts, etc., and the drives used.

For all current fixed drive conveyors, Interroll offers matching conveyor rollers, with the RollerDrive EC5000, the Pallet Drive and PolyVee belt even drives and drive elements. When using a RollerDrive as drive, it is recommended to place it in the middle of the driven conveyor rollers (for information about the Pallet Drive, see the separate product documents). If many rollers have to be driven, then PolyVee belts offer advantages over round belts. The use of PolyVee belts reduces the number of roller revolutions with increasing distance to the RollerDrive.

Friction conveyor

Friction conveyors are generally used to transport and accumulate materials. The special thing about friction conveyors is that an accumulation of materials can be accomplished with only little accumulation pressure when the drive is switched on. The same situation on a fixed drive conveyor would cause the materials that were stopped first to receive so much pressure from the subsequent materials that fragile cardboards could be damaged. Friction conveyors are well suited for buffer sections with non-uniform loading and unloading.

Friction conveyor rollers are available with many different drive elements, see page 191. Even a conveyor with drive shaft can be used as friction conveyor. The guide wheel of series 2600 enables not only guiding a round belt, but it also enables the drive shaft to turn while the wheel remains at rest. It must be ensured that the round belt does not slip through as this could significantly shorten its service life. For additional information, see page 191.

For some application's, it is a disadvantage if the materials touch, even if the accumulation pressure is reduced by the friction operation. In this case, a conveyor working at zero pressure accumulation may be better suited – see the next chapter (for additional information about friction conveyors, see page 191).

Zero pressure accumulation conveyor

The zero pressure accumulation conveying is often abbreviated as ZPA. A ZPA conveyor is generally divided into zones. The zone length is based on the length of the conveying good or the longest conveying good. Each zone features an option of identifying conveying goods, e.g. via a photo cell. In addition, every zone can be switched on and off. The zones are driven in different ways, see the examples below.

One option consists of a central drive, often a gear motor, that drives a flat belt. The flat belt is pressed onto the rollers using a switchable unit or guided past them. In the case of bypassing, the rollers are also often decelerated. It is feasible that the flat belt is pressed onto only a few rollers of a zone and the remaining rollers are connected with them by means of other drive elements. In many cases, this switching unit consists of pneumatic valves. They frequently cause an undesired noise level. A high level of energy can be expected for this ZPA solution since the powerful gear motor must also be powered if, for example, only one conveying good has to be moved on a 40-zone section.

Another option always presses the flat belt against a section of a roller in every zone. The remaining portion of the roller is switched in or out via a coupling. The remaining rollers of every zone are connected with the driven roller via other drive elements.

Another concept is the use of decentral drives. Motor rollers are often used for this purpose. In this case, drives which are directly driving the respective rollers, are installed in one or several rollers of a zone. A drive element connecting the entire conveyor is redundant. The remaining rollers of a zone are generally connected with the motor roller(s) using PolyVee or round belts. The zones can be activated or deactivated by purposefully switching the motor rollers on or off.

Depending on the length of the conveyor, the design with central drive usually falls below the investment costs of a solution with motor rollers. However, the operating costs tend to be higher due to the constant turning of the drive, even when nothing may be conveyed at the time. For most solutions with motor rollers, higher investment costs are possibly amortized after a short time.

Not only the lower energy consumption speaks in favor of a solution with motor rollers, but also the compact design. The motor is installed in a roller and does not have to be placed next to or below the conveyor.

Compared to gear motors, motor rollers are maintenance-free, they do not have to be greased and generally offer a higher safety level with a protected extra-low voltage.

But solutions with motor rollers can also have disadvantages. For solutions with many motor rollers per zone, the availability decreases – the more motors are being used, the higher the probability that a motor roller fails.

For this reason, Interroll recommends the use of the RollerDrive EC5000. In this case, one RollerDrive per zone is generally sufficient, and flexible control concepts are available. Furthermore, the controls offer many other options, such as change of direction of rotation or start and stop ramps which are not being offered by conventional ZPA conveyors.

Drive elements

With respect to drives, Interroll distinguishes between the actual drive, such as RollerDrive, drum motor, Pallet Drive, gear motor, etc. and the drive elements. Drive elements refers to different types of the torque transmission. Only the following drive elements are considered in this chapter:

- Toothed belt
- PolyVee belt
- Round belt

Chains

The chain is a tried and trusted method for driving conveyor rollers and conveyor elements in conveyor systems. Chains are characterized by their robustness and durability and are not sensitive to dirt and environmental influences. Very high levels of power can be transmitted with a chain. It is recommended to protect the chain drive against inadvertent contact.

Chains are not maintenance-free and are relatively loud in operation. They must be lubricated regularly in order to achieve an optimum service life. The noise created by a chain as drive element increases with increasing speed. For this reason, speeds higher than 0.5 m/s are not recommended.

Conveyor rollers with flanges welded on are often used for guiding pallets. Guiding pallets via flanges increases the power demand and must be taken into account during the dimensioning of the drive and drive elements.

The maximum drive length to be moved by a drive is limited by the permissible load of the chain. The following factors determine the maximum drive length "L":

- The permissible tensile load of the chain F_{MAX} in N
- The gravitational force of the individual material to be transported F_T in N
- The roller resistance μ of the conveyor track, whereby a value of 0.1 is generally selected
- The projected conveying speed "S" in m/s
- The placement cycle "t" of the materials (in S), i.e. the time between two successive pieces of material to be conveyed

The maximum drive length "L" is being calculated:

$$L = \frac{F_{MAX} \cdot S \cdot t}{F_T \cdot \mu}$$

If the drive station is positioned in the middle of the conveyor for the drive from roller to roller, then twice the drive length can theoretically be implemented. The sprockets that transfer the drive output must not be overloaded in such a case.

Based on the overall efficiency of this system, long drive lengths should be avoided. In many cases, drive lengths of more than 15 m have proven to be problematic.

F_{MAX} can be determined with the permissible breaking load F_B of the chain used. A safety factor of 7 (for which the wear of the chain is also within an acceptable range) is generally used for this purpose so that F_{MAX} can be determined as follows:

$$F_{MAX} = \frac{F_B}{7}$$

According to DIN, the following breaking loads must be assumed:

Chain designation	Breaking load F_B	F_{MAX}
06B (3/8")	9100 N	1300 N
08B (1/2")	18,200 N	2600 N
10B (5/8")	22,700 N	3243 N

The drive output "P" required for maximum length can be calculated as follows:

$$P = \frac{L \cdot \mu \cdot F_T}{t}$$

Tangential transmission of force

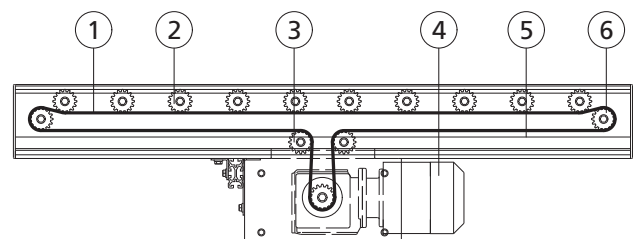

The tangential chain drive is characterized by its good level of efficiency and simple design. The drive head (2) consists only of one sprocket. For this reason, the installation length of the conveyor roller is shorter for a roller-to-roller drive. A single chain (1) drives all of the rollers in a conveyor. The chain is guided to the sprockets by a chain guide profile. The chain guide profile (5) is usually made of special plastic and must guide the chain extremely precisely.

When used in fixed drive conveyors, the sprockets are permanently connected with the tube of the conveyors. Friction conveyors use rollers whose sprockets are not permanently connected with the outside tube. 1 to 2 teeth of the sprockets

PLANNING BASICS

DRIVE ELEMENTS

mesh into the chain and only transfer the driving power required for the individual roller. The chain can be guided either along the top or bottom of the conveyor rollers. The precise positioning of the chain guide in relation to the conveyor rollers is extremely important. The maximum play in terms of height is 0.5 mm. The central motor station (4) must be installed in such a way that the driving side of the chain is as short as possible. It is advisable to provide the motor station with additional equipment for adjusting the chain tension. Idler pulleys (3, 6) guide the chain at the drive and/or end of conveyor in the corresponding direction. It is also possible to use the last conveyor rollers as chain deflection. In this case, it must be ensured that these rollers feature a DIN gearing.

Idler pulleys, which have to carry not only the load of the material to be conveyed, but also the chain traction forces, must be checked specifically with regard to their permissible bearing load. The driven conveyor length is restricted by the permissible breaking load of the chain and by the weight of the material to be conveyed.

The roller spacing (roller pitch) can be selected as required with tangential drives. Compared with roller-to-roller drives, the conveyor rollers are easy to fit and remove with tangential drives since they are not wrapped by the chain.

Starting at 1,000 operating hours, a lengthening of the chain of up to 2 % can be expected.

Wrapped force transmission

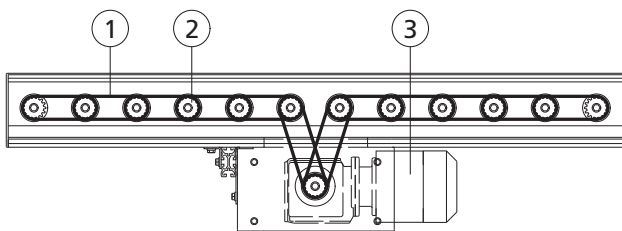

With wrapped force transmission, every conveyor roller is connected to the next one by a chain (1). For this reason the conveyor rollers require double sprocket heads (2). They need more space than with a tangential drive, so that the installation length of the roller is longer. Double sprocket heads always feature a DIN gearing (standard gearing).

An additional chain guide is not required. The roller pitch is subject to very tight tolerances and depends on the chain pitch.

$$t = P_c \cdot \frac{nc - nt}{2}$$

- t = Roller pitch
- nc = Number of chain links
- nt = Number of teeth of drive head
- Pc = Chain pitch

The maximum conveyor length depends on the drive output of the motor station (3) and the permissible breaking load of the chain. The chain experiences its maximum load at the motor station. The tolerances for the roller pitch "Pr" and the breaking load are listed in the following table.

Chain pitch/ designation	Pc [mm]	Tolerance of Pr [mm]	Breaking load [N]	F _{max}
06B (3/8")	9.52	0 to -0.4	9100	1300 N
08B (1/2")	12.70	0 to -0.5	18200	2600 N
10B (5/8")	15.88	0 to -0.7	22700	3243 N

- Pc = Chain pitch
- Pr = Roller pitch

Toothed belt

The share of toothed belts as drive element in roller conveyor systems is declining. Toothed belts are generally used from roller to roller and are unable to negotiate curves. Compared to round or PolyVee belts, the power requirement of a toothed belt is significantly higher because of its design. This must be taken into account in the selection of the drive. Toothed belts pose a high demand on the tolerance of the roller pitch since the tooth engagement is form-fit with the profile of the drive head. Interroll recommends obtaining the tolerances to be followed from the manufacturer of the selected toothed belt.

One advantage of the toothed belt compared to round and PolyVee belts, is the fact that it passes movements without slipping when used properly. On top of that, toothed belts are low-noise and maintenance-free, lubricating or retensioning is not required.

The drive length of a conveyor with toothed belt drive should be dimensioned so that the overall load of 12,000 N conveying good being conveyed at the same time is not being exceeded.

For the roller series 3500 and the RollerDrive EC5000, a maximum toothed belt width of 12 mm and a Poly-Chain GT gearing is recommended.

PolyVee belt

PolyVee belts are ribbed V-belts that are generally used for the torque transmission from roller to roller in roller conveyor systems. The belts must feature a flexible tension member which renders them significantly less flexible than most round belts. Nevertheless, they can accept tolerances within the roller pitch because of their flexibility and used as drive elements in curves. For the installation of PolyVee belts, Interroll recommends the use of a PolyVee tensioning device, see page 183.

Compared to round belts, PolyVee belts can transfer a higher torque of up to 300 %, the service life is longer and, when used properly, a PolyVee belt does not slip over the drive head. In start-stop operation, the rollers can be stopped more precisely and, compared to round belts, a higher number of conveyor rollers can be driven because of the high torque transmission.

Due to the design of the PolyVee drive head and the small width of the belts, they can be placed very close to the side profile. This leads to an optimal tube utilization for conveying goods. With the small diameter of the PolyVee drive head, any contact of PolyVee belt and conveying good is generally ruled out.

In container conveyor systems, 2-rib and 3-rib PolyVee belts are generally used. Interroll offers PolyVee belts for these designs for the most common roller pitches, see page 182. The 9-rib drive head also allows using 4-rib belts. The ability of high torque transmission also carries with it a high demand on safety. Injuries, such as jammed fingers between PolyVee belt and drive head, must be avoided. Interroll offers a finger guard for the most common roller pitches. It does not have to be fastened to the side profile and, for this reason, can be used for almost all side profiles, see page 183.

Round belt

Round belts, also referred to as O-rings, are available in different materials, colors and diameters. They are often used for the torque transmission from roller to roller. Round belts are cost-effective with respect to their purchase, are very flexible and can be installed with ease. The disadvantage is a relatively poor power transmission and relatively short service life. For this reason, the use of PolyVee belts predominates in conveyor systems.

The round belt guides with the RollerDrive EC5000 can be carried out via grooves in the tube or a round belt drive head. The drive head made from polyamide offers the advantage that the round belts can be guided closer at the end of the RollerDrive or at the side profile of the conveyor. In this case, it is more likely to separate torque transmission and running surface of conveying goods. Furthermore, the concentric precision is increased since no mechanical change of the tube occurs compared to grooves in the tube.

The round belt drive head offers a higher conveyance for most belts because of its material. This significant advantage must be taken into account if acceleration and deceleration for start-stop operation are so high that the belt briefly slips and wears out because of it. The better the conveyance from the guide, the higher the wear in this case. Groove solutions in tubes and also the round belt drive head offer 10 mm wide grooves. This allows using round belts with a maximum diameter of 6 mm. In case of higher round belt diameters, there is the risk of two contact points of the round belt – at the bottom and at the side of the groove. In this case, the belt is subjected to two different speeds and experiences above average wear.

Flat belt

Flat belts are used for tangential force transmission. In this case, the flat belt is guided under the rollers and, in each case, pressed against a part of the roller. This can be the tube or a drive head. Flat belts are used to construct fixed drive conveyors and friction conveyors. It is also possible to drive zero-pressure accumulation conveyors with flat belts. In such a case, the flat belt is permanently driven. Stopping subsections is done by decoupling the roller with the moving flat belt. Given the constantly turning central drive, this type of zero-pressure accumulation conveying leads to significantly higher energy consumption. Interroll recommends the use of RollerDrive as an alternative.

Flat belts hardly ever need any maintenance. A precise guiding of the belt is required. The flat belt is generally put in motion by a gear motor can must be brought to a pretension of approx. 1 % with a tensioning device. The drive power is generally transmitted more reliably if the loop angle of the flat belt on the roller can be increased with narrowing wheels.

Interroll offers different products for the use of flat belts. The conveyor rollers of series 1700 are frequently used for fixed drive conveyors. The series 3500 as fixed drive head is available with a flat belt drive head. The series 3800 offers friction solutions for flat belts. And the series 2600 offers several pressure rollers to guide and press on flat belts.

Friction rollers

Introduction

If materials are accumulated on a roller conveyor and the rollers continue to be driven, it creates accumulation pressure. This accumulation pressure continues to grow the more materials are being driven by rollers. As a result, it can damage the underside of the material to be conveyed. In addition, it is possible that the first piece of material, which is generally stopped by a mechanical stopper, will be squashed. Friction rollers prevent these problems by reducing the accumulation pressure.

PLANNING BASICS

FRICTION ROLLERS

Friction rollers are based on the principle of the slip coupling. In this case, the friction force in the coupling must overcome the rolling friction between material and roller. Friction rollers offer the option of setting up accumulation conveyors with minimal accumulation pressure. When materials are stopped, the rollers will also stop. The drive of the friction rollers continues to turn in this case. When the stop is canceled, the complete roller units turn again and move the materials. In this case, the conveyance is load-dependent.

The bearing housing of the series 3800 is designed as a greased-for-life slip coupling and guarantees the roller's constant conveyor force. A tangential drive has proved itself to be especially economical when used on friction conveyors. For this purpose, a central drive moves a long chain or a flat belt. The flat belt or the chain are guided past the drive unit underneath the conveyor rollers so that all conveyor rollers are operating.

Application notes

- Conveying goods
 - Even and stable bases of the conveying goods are ideal so that each friction roller carries the material evenly. Soft, lightweight or uneven conveying goods, e.g. cardboards, can be unsuitable for a friction conveyor.
 - Only those conveying goods can be used that prevent a mutual lifting out because of their shape. If necessary, the number of conveying goods to be accumulated must be restricted.
 - Round conveying goods are generally not suitable since they distribute randomly on the conveyor during accumulation. To prevent round conveying goods from falling off of the conveyor during accumulation, a suitable side guide is required.

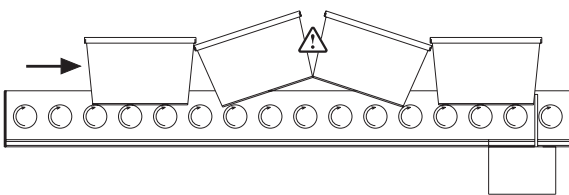

- The conveyor force, which is produced by the friction roller by means of friction, regulates itself relative to the weight of the conveying good. The conveyor force is seriously affected by the following factors:
 - Weight of conveying good
 - Base condition of conveying good
 - Position of conveying good
 - Humidity
 - Temperature
 - Percentage of accumulation mode over the entire running time

These factors have, to an extent, a considerable effect on the operation and operational lifespan of the conveyor roller. The task is to find out the sufficient conveyance for the respective conveying good to be conveyed. A dimensioning test under original conditions is generally required for this purpose.

- To enable starting up the conveyor even with complex conveying goods, the following measures may be helpful:
 - Selection of the correct friction roller. An adjustable or a double friction roller may be better suited.
 - Reducing the roller pitch: With less load on each roller, its conveyance ability is also reduced.
 - Creating a contact pressure from the drive head onto the bearing housing in axial direction.
 - Design of a minor incline in conveying direction
- Duration of accumulation mode
 - Accumulation mode should only be used for as long as is necessary. When it can be seen that no conveyance will take place, then the central drive should be switched off. No energy will be used and the service life of the conveyor system will be increased. An overtemperature of the abrading polymer elements must be avoided.
 - For long accumulation mode, steel sprocket drives offer an improved dissipation of the friction heat.
- Placement of conveying good
 - If the conveying good is significantly narrower than the friction roller, it can affect the conveyance ability. With single friction rollers, the conveyance decreases the further away the conveying good is from the friction drive.
 - The same applies to the center of gravity of a conveying good. The closer the center of gravity is to the friction drive, the better the conveyance.
- Friction roller
 - Flanges as well as other side guides cannot be used for friction rollers. The friction that is being created could possibly not be overcome by the conveyor force of the friction coupling.
 - The use of friction rollers represents a minimum requirement on the tolerance of the installation height of the rollers. If a friction roller that is installed at a low level is followed by a roller installed slightly higher, this may represent an interfering edge to the conveying good that cannot be overcome.
 - When using tube sleeves (e.g. PVC sleeves), a maximum sleeve material thickness of 2 mm is recommended.
- The maximum permissible conveying speed is 0.5 m/s.
- Use only under dry conditions
- The bearing housings that are part of the friction element, contain pockets. These pockets are filled with special grease. The grease must not be removed! It allows better startup values, due to the high adhesive force of the grease. In addition, friction heat that is being created, is dissipated better through the grease, and the wear of the polymer parts is reduced.

- The conveyance values listed below are non-binding. They refer to standard climate (65 % relative humidity and a temperature of +20 °C) and conveying good positioned in the center.

Conveyor force	Friction	Ø Friction roller [mm]
4 – 6 %	One-sided friction element	50
2 – 5 %	One-sided friction element	60
8 – 13 %	Two-sided friction element	30/50/60/80
4 – 6 % (12 %)	One-sided, adjustable friction element	50/60

Functional differences

Series 3800

Series 3800 offers different drive heads. A drive head is set in motion using a drive element and turns inside the bearing housing. The bearing housing applies force onto the drive head with the weight of tube and material to be conveyed. This friction force causes the conveyance of bearing housing and tube. The material to be conveyed is moved through the rotation of the tube.

If the material is stopped, the tube stops and the drive head turns inside the bearing housing.

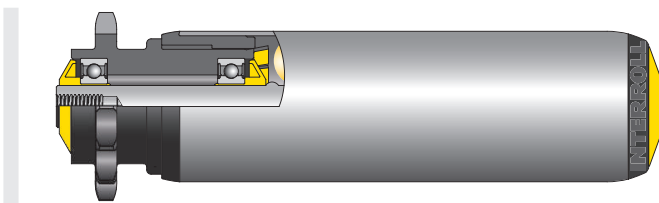

The product description of series 3800 is located on page 116.

Series 3800 – adjustable

With the adjustable series 3800, a 1/2" steel sprocket drive head with 14 teeth is available, whereby the operating principle corresponds to the one described above. In addition, a male threaded shaft protrudes from the roller on the other side of the drive head. There is a nut and a spring on the shaft. Tightening the nut tensions the spring, which exerts an axial force from the drive head onto the bearing housing. This axial force increases the conveyance to up to 12 % of the roller load. The more the nut is tightened, the earlier the tube is turning.

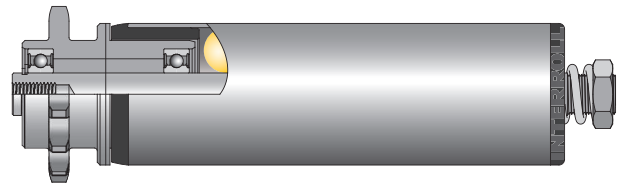

The product description of the series is located on page 116.

Series 3800 light

The series 3800 light offers a single friction solution as well as a double friction solution. The rollers have a diameter of 30 mm. The single friction rollers are equipped with steel sprocket heads and the double friction rollers with polymer drive heads for flat belts. The operating principle of the single friction corresponds to that of series 3800 and that of the double friction to that of series 3870.

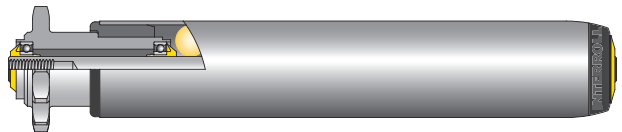

The product description of series 3800 light is located on page 112.

Series 3870

Series 3870 offers different polymer sprocket heads. A drive head and a bearing assembly on the other side are pressed into an internal tube. This unit is integrated into the external tube. The operating principle corresponds to series 3800, whereby the internal tube rotates in the two bearing housings of the external tube. If a material to be conveyed is stopped, the drive head turns together with the internal tube, and the external tube is standing still. The advantage of this solution is that both sides of the roller feature a friction unit and conveyor force is generated with an off-center load.

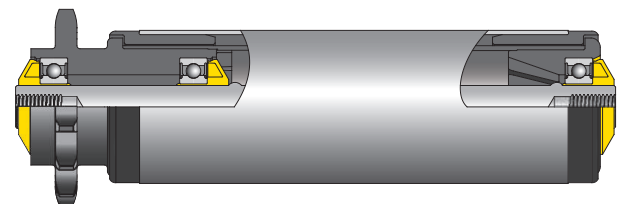

The product description of series 3870 is located on page 126.

PLANNING BASICS

HOW TO BUILD A CURVE?

How to build a curve?

It is possible to build roller curves with cylindrical rollers. With such a design, materials to be conveyed are not conveyed in the center of the curve, but alongside a required side guide. This requires more energy and it poses the risk of damage to the side guide or material that is being conveyed. For this reason, the design with tapered conveyor rollers is recommended.

The diameter of the tapered rollers increases towards the direction of the outside curve diameter. With the increasing diameter, the circumferential speed increases. This allows materials to be transported through the curve without losing their orientation. With the usual speeds (max. 0.8 m/s) and ideal curve design, a side guide is not required.

Interroll offers different curve-capable rollers that feature the designation KXO. These are rollers with cylindrical steel tube onto which tapered elements are pushed. The following series are suitable for use in roller curves.

Series	Based on Ø [mm]	Conicity	Drive elements
3500KXO light	20	1.8°	Round belt
1700KXO	50	1.8° and 2.2°	Round belt
3500KXO	50	1.8° and 2.2°	Round belts, PolyVee belts, chains

Curve dimensioning

Based on this curve diagram, Interroll recommends the following steps:

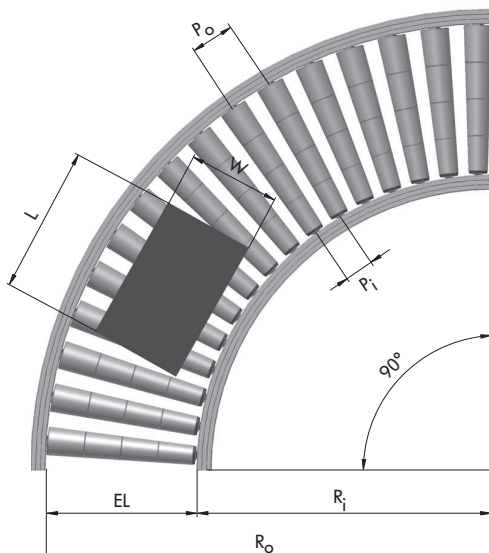

EL	Installation length of the conveyor roller	R_i	Internal radius of the curve
L	Max. conveying good length	P_o	Roller pitch on the external diameter
W	Max. conveying good width	P_i	Roller pitch on the internal diameter
R_o	External radius of the curve		

- Curve definition
 - Driven or non-driven curve
 - With driven curves, determination of the drive elements (see sub-chapter Drive elements on page 195)
- Selection of the roller series (drive element, based on a diameter of 20 or 50 mm)
 - Series 3500KXO light see page 96
 - Series 1700KXO see page 70
 - Series 3500KXO see page 100
- Determining the dimensions of the largest possible conveying good
- Selecting the inside radius (note under "Radii")
- Calculating the minimal outside curve radius R_o

$$R_o = 50 \text{ mm} + \sqrt{(R_i + W)^2 + \left(\frac{L}{2}\right)^2}$$

- Calculating the minimal installation length of the conveyor rollers
Installation length $EL_{\text{MIN}} = R_o - R_i$
- The reference lengths of the rollers are calculated based on the lengths of the tapered tube sleeves. The lengths must be greater than the calculated installation length.
- Calculating the actual installation length of the selected curve roller (see the note in the respective chapter of the roller series)
- Calculating the actual outside curve radius R_o
 $R_o = EL + R_i$ with selected standard EL
- Determining the roller pitch at the inside diameter or angle between the rollers
- Calculating the roller pitch at the outside diameter P_o

$$P_o = P_i \cdot \frac{R_o}{R_i}$$

Installing the rollers/RollerDrive



For the curve construction, it must be taken into account that the top side of the curve RollerDrive is level. Hence, the fastening shaft is not horizontal. As a result, vertically arranged side profiles do not have a 90° angle. For this reason, Interroll

recommends an angle compensation so that the fastening shaft does not experience any warping. The EC3500 with protection rating IP54 is exclusively available for installation in the curve.

The installation length of curved sections must be longer than that of straight sections to ensure that the conveying good does not touch the side guide in the curve. Please select the next larger installation length grid.

Drive

The RollerDrive has established itself as the drive for powered roller curves. It allows implementing a cost-efficient, compact and quiet curve. RollerDrive in conjunction with PolyVee belts as drive element are the simplest solution for torque transmission in curves. Such curves can be constructed and set up in an easy way – for constantly rotating as well as for curves for start-stop operation.

Drive element

Round belts and PolyVee belts are suitable as drive element.

Round belts can be guided via grooves which are located in the area of a tube projection. As an alternative, round belts can also be guided via a drive head at the inside radius.

PolyVee belts are exclusively guided via a drive head, also at the inside radius.

The most frequent solution is the PolyVee belt. For use in curves, 2-rib and 3-rib flexible belts are suitable. The belts must occupy the first grooves from the direction of the inner curve radius. A distance of one groove is required between the two belts.

Length of tapered elements

1.8° elements: The first tapered element has a length of 45 mm or 95 mm. All additional elements have a length of 100 mm. The total length of the tapered elements can be selected in increments of 50 mm. The different lengths of the first tapered elements result in 2 different inside curve radii.

2.2° elements: The length of the first tapered is always 140 mm. Hence, the inner curve radius does not vary.

Radii

Different inside curve radii can be created with the different Interroll Curve Rollers. A material will be conveyed perfectly through a curve only if the radii are being maintained.

Curve rollers of series 1700KXO and 3500KXO can be manufactured with a tube projection. It is possible that the tube projection is located on the side of the tapered element with the smaller diameter. The first tapered element will then have the corresponding distance to the curve side profile. With this design,

it must be taken into account that the inner curve radius must be reduced with a tube projection of more than 20 mm. A tube projection on the side of the tapered element with the larger diameter does not have any effect on the inner curve radius.

Inside curve radii for rollers with PolyVee or round belt drive head

Inner curve radius	Conicity	Roller series	Roller reference lengths [mm]
660 mm	2.2°	3500KXO	190, 240, 290, 340, 440, 540, 640, 740
820 mm	1.8°	3500KXO	150, 250, 350, 450, 550, 650, 750, 850, 950
770 mm	1.8°	3500KXO	200, 300, 400, 500, 600, 700, 800, 900, 1000

Inner curve radii for non-driven rollers

Inner curve radius	Conicity	Roller series	Roller reference lengths [mm]
357 mm	1.8°	3500KXO light	150, 250, 350, 450, 550
357 mm	1.8°	3500KXO light	200, 300, 400, 500, 600
690 mm	2.2°	1700KXO	190, 240, 290, 340, 440, 540, 640, 740
850 mm	1.8°	1700KXO	150, 250, 350, 450, 550, 650, 750, 850, 950
800 mm	1.8°	1700KXO	200, 300, 400, 500, 600, 700, 800, 900, 1000

PLANNING BASICS

HOW TO BUILD A CURVE?

Inner curve radii for rollers driven via chain

Inner curve radius	Conicity	Roller series	Roller reference lengths [mm]
690 mm	2.2°	3500KXO	190, 240, 290, 340, 440, 540, 640, 740
850 mm	1.8°	3500KXO	150, 250, 350, 450, 550, 650, 750, 850, 950
800 mm	1.8°	3500KXO	200, 300, 400, 500, 600, 700, 800, 900, 1000

Inside curve radii for rollers with grooves

Grooves are applied within a tube projection at the inner curve radius. The table "Inside curve radii for non-driven curves" lists the curve radii for the rollers of series 1700KXO. The tube projection must then be subtracted from the corresponding curve radius.

Roller pitch

The roller pitch depends on the selected drive element.

PolyVee belt: For example, if a PolyVee belt is used in the curve for a roller pitch of 75 mm, then a hole pitch of 73.7 mm must be planned at the inside radius. When using rollers with a conicity of 2.2° and PolyVee belts for a roller pitch of 60 mm, then a hole pitch of 58.7 mm must be planned at the inside radius. The roller pitch at the outside radius can be calculated using the following formula:

$$P_o = P_i \cdot \frac{R_o}{R_i}$$

- P_o = Roller pitch on the outside diameter
- P_i = Roller pitch on the inside diameter
- R_o = Outside radius of the curve
- R_i = Internal radius of the curve

Interroll recommends an angle of 5° between two rollers. The angle must not be greater than 5.5°.

Round belts: Any length can be used here. To ensure a sufficient distance of the rollers, Interroll recommends not to plan more than 22 rollers in a 90° curve. This also applies to non-driven curves. For the series 3500KXO light and a radius of 357.5 mm, the following roller pitches (T_i) and roller counts can be used.

Number of rollers	22	20	18	16	14	12	10	8
Roller pitch T_i [mm]	25.53	28.08	31.20	35.10	40.11	46.80	56.16	70.19

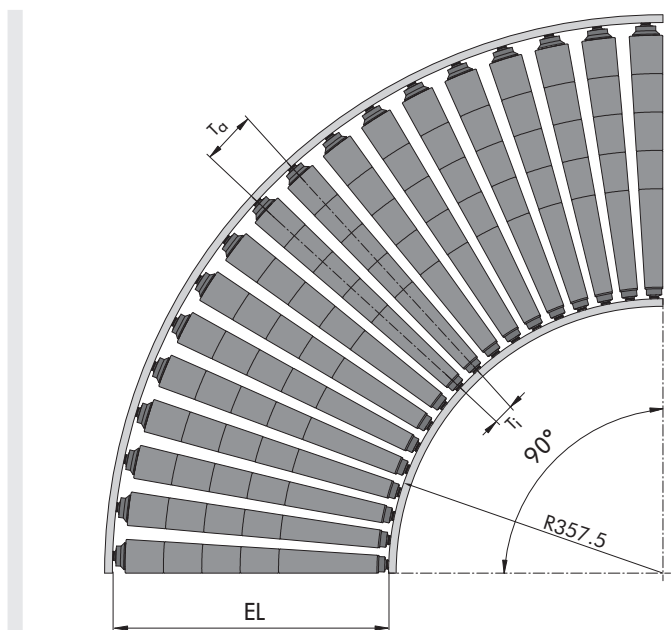

Chains: The chain as drive element allows only a limited number of roller pitches. The roller pitch is always a multiple of the 1/2" chain pitch and can be calculated as follows:

$$P_{Chain} = \frac{(N_T - N_c)}{2} \cdot 12,7$$

- P_{chain} = Chain pitch
- N_c = Number of teeth
- N_T = - Number of chain links

The calculation of the roller pitch is performed at the outside radius. With a roller-to-roller drive, the inside and outside sprockets are used alternately. The roller pitch should be dimensioned so that a chain on the outside sprockets is perfectly tensioned. With the same roller pitch in the curve, the chain on the inside sprockets will be tensioned a little bit less because of the reduced distance of the sprockets to each other.

The roller pitches at the inside and outside radius must be calculated on the basis of the chain pitch.

PLANNING BASICS

HOW TO BUILD A CURVE?

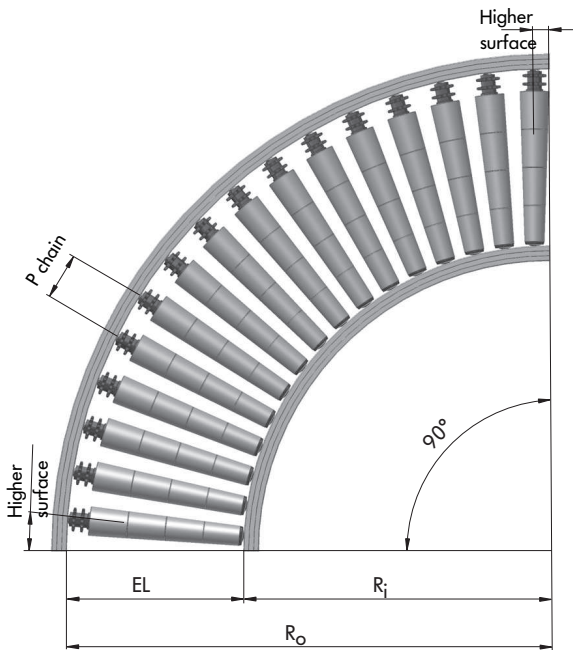

The following information on the number of conveyor rollers required relates to a 90° curve on which a higher surface to the 90° angle of the side frame has been designed in for equalization.

Reference length [mm]	Pitch measured on the sprocket [mm]					
	88.9	101.6	114.3	127.0	139.7	152.4
250/300	19	16	14	13		
350/400	20	18	16	14	13	
450/500		19	17	15	14	13
550/600		21	18	17	15	14
650/700			20	18	16	15
750			21	19	17	16
800				19	17	16
850/900				20	18	17

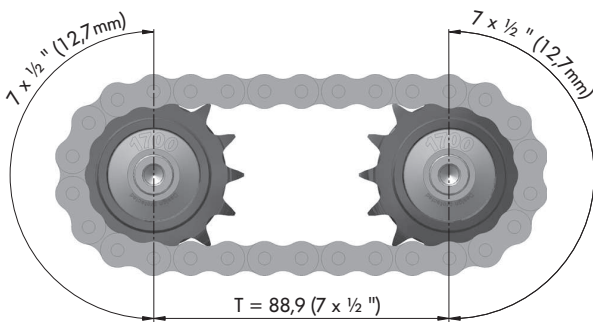

The following theoretical pitches (measured at the sprocket with a pitch of 1/2" and 14 teeth) have been proven and tested:

Number of chain links	Pitch measured on the sprocket [mm]
28	88.9
30	101.6
32	114.3
34	127.0
36	139.7
38	152.4

Number of rollers

The calculation or determination of the roller pitch and the angle of the roller curve result in the number of rollers to be used, which is not always an even number. In this case, the value must be rounded up or down.

If a PolyVee belt is used in the curve for a roller pitch of 73 mm (based on a straight conveyor line), it results in an even roller count for the following curve angles:

Angle	Number of rollers
30°	6
45°	9
90°	18
180°	36

Speed

For a conveying good to be conveyed perfectly through the curve, the curve speed and the speed of the straight conveyor line must be identical before and after the curve. The curve speed refers to the average speed. If the speeds of straight and curve are different, the conveying good can lose its orientation and, as a result, reach the side guide.

Different forces occur in a curve. If the centrifugal force is greater than the static friction force, conveying goods will almost always lose their orientation. This occurs at speeds over approx. 0.8 m/

PLANNING BASICS

DIMENSIONING OF MAGNETIC SPEED CONTROLLER

s. At that point, conveying goods will no longer be conveyed through the center of the curve and come into contact with the side guide at the outside radius. This depends on various factors, such as material and condition of the underside of the conveying good, and these factors should also be taken into account during the planning of the curve.

Tapered elements of conventional curve rollers carry the risk of shifting on the tube. Interroll secures the tapered elements without creating an interfering edge that is visible on the outside.

Deep freezing

Roller curves can also be operated in the deep freeze area. An ideal drive is the RollerDrive EC5000 in deep freeze design. Driven rollers should feature oiled ball bearings so that the required drive power is not increased unnecessarily. Interroll recommends PolyVee belts as drive element. They have to be watched for suitability for deep freezing and that the belt tension is not too high.

Dimensioning of magnetic speed controller

The Magnetic Speed Controller MSC 50 is a mechanical speed controller that ensures a controlled speed on gravity conveyors with conveying goods weighing up to 35 kg.

In contrast with conventional products, the speed controller operates without a gear box, thus enabling startup for very lightweight containers starting at 0.5 kg. The maximum mechanical output is 28 W, thus providing the required consistently high braking power for heavy containers. The operating principle is based on an eddy current brake. A double shielding of the magnets enables a uniform braking action.

Conventional products often contain brake shoes. The heavier a conveying good, the stronger the braking of these brake elements. This purely mechanical braking process causes wear. It means that such products have to be replaced after a certain time since the brake shoes are worn off. Such a wear does not take place in the MSC 50.

The hexagon shaft used serves the torque within the side profile. A loose, form-fit installation of the hexagon shaft is possible with hexagon holes in the side profiles. A hole size of 11.5 mm is required for an oblique installation. With a fixed installation using a female threaded shaft, a minimum torque of 20 Nm must be applied. Interroll recommends the additional use of a screw locking device.

The speed controller without PU sleeve is manufactured with a tube diameter of 51 mm. Together with conveyor rollers of 50 mm diameter, a minimum higher surface of 0.5 mm is created. This provides sufficient contact to the conveying good, which leads to an optimal braking function.

The distribution, number and design of the speed controller in a conveyor track depends on many parameters:

- Incline of conveyor track
- Roller pitch
- Infeed speed, e.g. by a sorter
- Conveying good weight
- Condition of the underside of the conveying good

The data listed below has been determined by means of numerous tests. Conveying goods with optimal undersides were used for this purpose. The data is intended to provide a reference point for the dimensioning of applications, whereby the combination of critical parameters is very large. Due to the multitude of influencing factors, Interroll cannot provide specific information about conveying speeds and, for this reason, recommends to empirically determine the final layout:

- Lightweight conveying goods can run very slowly (approx. 0.01 m/s).
- Under optimal conditions, heavy conveying goods can run at 0.5 m/s.
- The design with PU sleeve is intended to improve the static friction for smooth plastic containers. The PU sleeve is particularly recommended in combination of conveyor tracks with large inline and high conveying good weights.
- For cardboard boxes and many other conveying goods, the friction in combination with a zinc-plated steel tube is sufficient.
- Inclines from 5 % to 10 % were examined in numerous tests. The following distances between the Magnetic Speed Controllers were tested successfully:

Conveying good weight [kg]	Distance of MSC 50 [mm]
0.5 to 10	Maximum 2000
10 to 20	800 to 1500
20 to 35	Adjusted to the length of the conveying good

- With infeed speeds into the gravity conveyor greater than 1 m/s, Interroll recommends the installation of three to four MSC 50 at the beginning of the gravity conveyor. The placement on the first 1,000 mm is used for immediate reduction of the speed. On the rest of the gravity conveyor, the distance values specified above can be applied as guide values.

Material specification

Tubes

Material	Standards	Specification
Uncoated steel, zinc-plated steel	DIN EN 10305-1 DIN EN 10305-2 DIN EN 10305-3	Limited tolerances and material specifications by Interroll
Zinc-plating	DIN EN ISO 19598	Galvanized zinc sleeve with additional blue passivation (chromium VI-free) Sleeve complies with RoHS regulations Plating thickness 6 to 15 µm
Stainless steel	DIN EN 10296-2	1.4301 (X5CrNi18-10) and 1.4509 (X2CrTiNb18) Limited tolerances by Interroll
Aluminum	DIN EN 754-1+2 (Ø20) DIN EN 755-1+2 (Ø50)	AW 6060 T66 (AlMgSi 0.5 F22) For 20 mm E6/EV1, stained, natural and anodized Surface layer thickness 20 µm, isolating and non-conductive For 50 mm mill-finished, unfinished, thus conductive
PVC	–	PVC-U (rigid polyvinyl chloride, softener-free, silicon-free, highly impact-proof) Contains only materials, which have been tested and registered to comply with the REACH Directive (EC No. 1907/2006) RAL7030 (stone gray) RAL7024 (dark gray) RAL5015 (sky blue)

Bearings

Precision ball bearings, lubricated (689 2Z, 6002 2RZ, 6003 2RZ, 6204 2RZ, 6205 2RZ), used by Interroll:

Standard	DIN 625
Material	Rings and balls are made of chrome steel of material grade 100Cr6 Hardness: 61 ± 2 HRC, with metal cages, 689 2Z: Polyamide cage
Bearing play	689 2Z: C0 All others: C3
2RZ Seal	Non-grinding 2-lip seal with labyrinth effect manufactured from steel-reinforced acrylonitrile-butadiene rubber (NBR)
2Z Seal	Non-grinding cover discs made of sheet steel
Lubrication	Multi-grade grease, silicon-free

PLANNING BASICS

MATERIAL SPECIFICATION

Precision ball bearing, lubricated (6002 2RZ)

Standard	DIN 625
Material	Rings and balls are made of chrome steel of material grade 100Cr6 Hardness: 61 ± 2 HRC, with metal cages
Bearing play	C3
2RZ Seal	Non-grinding 2-lip seal with labyrinth effect manufactured from steel-reinforced acrylonitrile-butadiene rubber (NBR)
Lubrication	Multi-grade oil, silicon-free

Precision ball bearings made of stainless steel, lubricated (6002 2RZ, 6003 2RZ)

Standard	DIN 625
Material	Rings and balls made of stainless steel, material 1.4125 (X105CrMo17), with a material grade to comply with AISI 440C Hardness: 58 ± 2 HRC, with polyamide cages
Bearing play	C3
2RZ Seal	Non-grinding 2-lip seal with labyrinth effect manufactured from steel-reinforced acrylonitrile-butadiene rubber (NBR)
Lubrication	Multi-grade grease, silicon-free

Steel conical mount

Material	Wheel body material DX53D + Z, zinc-plated Bearing parts, hardened
Lubrication	Multi-grade grease, silicon-free

Polymer bearing

Material	External ring and cone made of polypropylene Balls made of carbon steel or stainless steel
Lubrication	Multi-grade grease with low viscosity, silicon-free, FDA-tested

Shafts

Material	Standards	Specification
Uncoated steel, zinc-plated steel	DIN EN 10277	1.0715 (11SMn30) Limited tolerances and material specifications by Interroll
Zinc-plating	DIN EN 19598	Galvanized zinc sleeve with additional blue passivation (chromium VI-free) Sleeve complies with RoHS regulations Plating thickness 6 to 15 µm
Stainless steel	DIN EN 10088-3	1.4305 (X5CrNi18-9) Limited tolerances by Interroll

Polymers

Interroll uses components made of polymer in almost all conveyor elements. Polymer has many advantages over steel:

- Sound reduction
- Easy to clean
- Excellent impact strength
- Corrosion resistance
- Lightweight
- High quality design

Properties and applications

Polymer	Properties	Uses
Polyamide (PA)	<ul style="list-style-type: none"> • Outstanding mechanical properties • Excellent wear resistance • Low coefficient of friction • Good chemical resistance 	Sprocket drive heads, seals and bearing seats
Polypropylene (PP)	<ul style="list-style-type: none"> • Low specific weight • Excellent heat resistance • Not hygroscopic • Good chemical resistance 	Wheels, seals and bearing seats
Polyvinyl chloride (rigid PVC)	<ul style="list-style-type: none"> • Scratch-resistant • Impact-resistant • Good chemical resistance 	Tubes for polymer conveyor rollers
Polyoxymethylene (POM)	<ul style="list-style-type: none"> • Outstanding mechanical properties • Excellent wear resistance • Low coefficient of friction • Very dimensionally stable • Minimal absorption of water • Used on parts which require a very high level of precision 	Toothed belt drive head and slide bearing

Resistance

Symbol	Meaning	Explanation
++	Very good resistance	Continuous exposure to the medium causes no damage
+	Generally resistant	Continuous exposure to the medium can cause damage, which is reversible when no longer exposed to the medium
-	Mostly non-resistant	Only resistant if there are optimum ambient and application conditions but generally some damage is to be expected
--	Completely non-resistant	The medium may not come into contact with the polymer

The resistance of the polymers is affected by temperature, exposure to force, UV exposure, and the duration of exposure and concentration of the medium.

PLANNING BASICS

MATERIAL SPECIFICATION

A thorough suitability test of the polymer to be used by the user is indispensable. The following overview serves as orientation aid.

Product	Polyamide (PA)	Polyoxymethylene (POM)	Soft PVC	Rigid PVC	Polypropylene (PP)
Ethers	++	++	-	++	-
Lower alcohols	++	++	++	-	++
Petrol	++	+	--	++	-
Esters	++	--	--	--	-
Fats	++	++	-	++	+
Hydrofluoric acid	--	--	-	-	-
Ketones	++	-	--	--	++
Aliphatic hydrocarbons	++	++	--	++	++
Aromatized hydrocarbons	++	+	--	--	-
Chlorinated hydrocarbons	-	++	--	--	--
Unsaturated, chlorinated hydrocarbons	+	++	--	--	--
Weak bases	+	++	++	++	++
Strong bases	-	++	-	++	++
Mineral oil	++	++	-	++	-
Oils	++	++	-	++	+
Oxidizing acids	--	--	-	--	--
Weak acids	--	-	++	++	++
Strong acids	--	--	++	-	--
Strong, organic acids	-	++	-	+	++
Inorganic salt solutions	++	++	++	++	++
Turpentine	-	-	--	--	--
Fuel mixture	+	++	--	--	-
Water	++	++	++	++	++

PLANNING BASICS

MATERIAL SPECIFICATION
